

LAVATHERM 88840

User manual

ProSteam condenser
dryer

Thank you for choosing one of our high-quality products.

To ensure optimal and regular performance of your appliance please read this instruction manual carefully. It will enable you to navigate all processes perfectly and most efficiently. To refer to this manual any time you need to, we recommend you to keep it in a safe place. And please pass it to any future owner of the appliance.

We wish you much joy with your new appliance.

Contents

<u>Operating Instructions</u>	3	Putting in extra items or taking items out before end of programme	25
<u>Important safety information</u>	3	Drying programme complete / removing laundry	25
<u>Environment</u>	5	<u>Drying rack</u>	25
<u>Product description</u>	7	<u>Care and cleaning</u>	27
<u>Control panel</u>	8	Cleaning fluff filter	27
Display	8	Cleaning the door seal	29
<u>First start-up</u>	9	Emptying the condensate tank	29
<u>Sorting and preparing laundry</u>	11	Cleaning heat exchanger	30
Laundry weights	12	Cleaning the water recirculation valve/filter	31
Opening loading door / loading laundry	12	Cleaning the drum	31
<u>ProSteam system</u>	12	Clean operating screen and housing	32
Fill steam water tank	12	<u>What to do if ...</u>	32
Water recirculation system	13	<u>SETTINGS</u>	35
Overview of ProSteam programmes	15	<u>Technical data</u>	37
Selecting the programme	17	<u>Hints for test institutes</u>	37
Select STEAM LEVEL	17	<u>Installation</u>	38
Selecting additional options	17	Appliance positioning	38
Setting DELAY function	18	Removing transport safety packaging	39
Starting the ProSteam programme	19	Drying rack unpacking	39
Changing a programme	19	Electrical connection	40
Putting in extra items or taking items out before end of programme	20	Door reversal	41
ProSteam programme complete / removing laundry	20	Special accessories	41
<u>Drying</u>	21	<u>Service</u>	41
Drying programmes overview	21	<u>Guarantee conditions</u>	42
Selecting the programme	22	<u>Guarantee/Customer Service</u>	42
Setting DRYNESS	22	<u>GREAT BRITAIN & IRELAND</u>	42
Selecting additional options	23	<u>European Guarantee</u>	43
Selecting TIME	24	<u>www.electrolux.com</u>	44
Selecting DELAY START	24		
Starting the drying programme	24		
Changing a programme	25		

Operating Instructions

Important safety information



Only operate the ProSteam programmes with distilled water!
Mains water causes damage to the appliance.



In the interest of your safety and to ensure the correct use, before installing and first using the appliance, read this user manual carefully, including its hints and warnings. To avoid unnecessary mistakes and accidents, it is important to ensure that all people using the appliance are thoroughly familiar with its operation and safety features. Save these instructions and make sure that they remain with the appliance if it is moved or sold, so that everyone using it through its life will be properly informed on appliance use and safety.

General safety

- It is dangerous to alter the specifications or attempt to modify this product in any way.
- This appliance is not intended for use by persons (including children) with reduced physical, sensory or lack of experience and knowledge, unless they have been given supervision or instruction concerning use of the appliance by a person responsible for their safety.
- Make sure that small pets do not climb into the drum. To avoid this, please check into the drum before using.
- Any objects such as coins, safety pins, nails, screws, stones or any other hard, sharp material can cause extensive damage and must not be placed into the machine.
- In order to avoid danger of fires caused by excessive drying, do not use appliance to dry the following items: cushions, quilts and the like (these items accumulate heat).
- Items such as foam rubber (latex foam), shower caps, waterproof textiles, rubber backed articles and clothes or pillows fitted with foam rubber pads should not be dried in the tumble dryer.
- Always unplug the appliance after use, clean and maintenance.
- Under no circumstances should you attempt to repair the machine yourself. Repairs carried out by inexperienced persons may cause injury or serious malfunctioning. Contact your local Service Centre. Always insist on genuine spare parts.
- Items that have been soiled with substances such as cooking oil acetone, petrol, kerosene, spot removers, turpentine, waxes and wax removers should be washed in hot water with an extra amount of detergent before being dried in the tumble dryer.
- **Danger of explosion:** never tumble dry items that have been in contact with inflammable solvents (petrol, methylated spirits, dry cleaning fluid and the like). As these substances are volatile, they could cause an explosion. Only tumble dry items washed with water.
- **Risk of fire:** items that have been spotted or soaked with vegetable or cooking oil constitute a fire hazard and should not be placed in the tumble dryer.
- If you have washed your laundry with stain remover you must execute an extra rinse cycle before loading your tumble dryer.
- Please make sure that no gas lighters or matches have accidentally been left in pockets of garments to be loaded into appliance

- When removing from the socket, never pull the mains plug by the cable, instead take a hold of the plug.
- The height adjustable screw feet must never be removed.
- The plug must be accessible after installing the machine
- Manifold plugs, couplings and extension cables must not be used. Risk of fire from overheating!
- Do not spray down the appliance with jets of water. Risk of electric shock!
- Do not lean on the open door. The appliance may tip over.
- Once the drying cycle or ProSteam programme has been interrupted, the laundry and drum may be hot. Risk of burns! Take care when removing the laundry.
- Take care when interrupting the ProSteam programme: Do not open the machine door during the steam phase. Hot steam may result in burns. The display shows a message to indicate the steam phase.
- The final part of a drying cycle occurs without heat (cool down cycle) to ensure that the items are left at a temperature that ensures that the items will not be damaged.
-  Caution – Hot surface:
Do not touch the back of the appliance while it is operating.



WARNING!

Never stop a tumble dry before the end of the drying cycle unless all items are quickly removed and spread out so that the heat is dissipated. Risk of fire!

- **Risk of electric shock!** Do not spray down the appliance with jets of water.

Installation

- Note the "Installation" instructions.
- **Important!** Appliance must be moved in vertical position for transport.
- This appliance is heavy. Care should be taken when moving it.
- When unpacking the appliance, check that it is not damaged. If in doubt, do not use it and contact the Service Centre.
- All packing must be removed before use. Serious damage can occur to the product and to property if this is not adhered to. See relevant section in the user manual.
- Any electrical work required to install this appliance should be carried out by a qualified electrician or competent person.
- Care must be taken to ensure that the appliance does not stand on the electrical supply cable.
- If the machine is situated on a carpeted floor, please adjust the feet in order to allow air to circulate freely under the appliance.
- After having installed the appliance, check that it is not pressing or standing on its electrical supply cable.
- If the tumble dryer is placed on top of a washing machine, it is compulsory to use the stacking kit (optional accessory).

Use

- The appliance is intended for drying and steam treatment of standard laundry in domestic applications.
- This appliance is designed for domestic use. It must not be used for purposes other than those for which it was designed.
- Only wash fabrics which are designed to be machine dried. Follow the instructions on each garment label.

- Do not dry unwashed items in the tumble dryer.
- Do not overload the appliance. See the relevant section in the user manual.
- Clothes which are dripping wet should not be placed in the dryer.
- Garments which have been in contact with volatile petroleum products should not be machine dried. If volatile cleaning fluids are used, care should be taken to ensure that the fluid is removed from the garment before placing in the machine.
- When using dry-cleaning sets: only use those products which are declared as suitable for the dryer by the manufacturer.
- Clean the micro-fine filter and fine strainer after each drying cycle or ProSteam programme.
- Do not use the machine without a lint filter or with a damaged lint filter. Risk of fire!
- Only fill the water reservoir for steam treatment with distilled water. Do not use tap water or any additives! The condensed water from this appliance's condensed water container can also be used, if it is filtered first (e. g. with a coffee filter).
- Clean the heat exchanger regularly.
- Never pull the power supply cable to remove the plug from the socket; always take hold of the plug itself.
- Never use the tumble dryer if the power supply cable, the control panel, the working surface or the base are damaged so that the inside of the tumble dryer is accessible.
- With stacked washer and ProSteam appliance: do not place objects on the appliance. These may fall off during operation.
- The lamp cover for the interior light must be screwed down tightly.
- Fabric softeners, or similar products should be used as specified by the fabric softener instructions.
- **Caution – hot surface** : Do not touch the door light cover surface when the light is switched on.

Child safety

- This machine is not intended for use by young children or infirm persons without supervision.
- Children often do not recognise the hazards associated with electrical appliances. Children should be supervised to ensure that they do not play with the appliance.
- Make sure that children and small animals cannot climb into the appliance's drum. Could endanger life! Keep the appliance door shut whenever it is not being used.
- Keep all detergents in a safe place out of children's reach.
- When discarding the appliance, cut the electrical supply cable and destroy the plug with the remaining cable. Disable to door catch in order to prevent young children from becoming trapped inside the machine while playing.

Environment

The symbol  on the product or on its packaging indicates that this product may not be treated as household waste. Instead it should be taken to the appropriate collection point for the recycling of electrical and electronic equipment. By ensuring this product is disposed of correctly, you will help prevent potential negative consequences for the environment and human health, which could otherwise be caused by inappropriate waste handling of this product. For more detailed information about recycling of this product, please contact

your local council, your household waste disposal service or the shop where you purchased the product.

Environmental tips

- In the dryer, laundry becomes fluffy and soft. Fabric softeners are not therefore needed when washing.
- Filtered condensed water can be used for ProSteam programmes.
- Your dryer will function most economically if you:
 - always keep the ventilation slots on the base of the dryer unobstructed;
 - use the loading volumes specified in the programme overview;
 - ensure you have good ventilation in the installation room;
 - clean micro filter and fine filter after every drying or ProSteam programme;
 - spin the laundry well before drying.



Energy consumption depends on spinning speed set in washing machine. Higher spinning speed - lower energy consumption.

Packaging material

The packaging materials are environmentally friendly and can be recycled. The plastic components are identified by markings, e.g. >PE<, >PS<, etc. Please dispose of the packaging materials in the appropriate container at the community waste disposal facilities.



WARNING!

When disposing of old appliances, remove the mains cable and dispose of together with the plug. Remove the door hook and ensure it is no longer lockable to prevent young children being trapped inside.

Product description

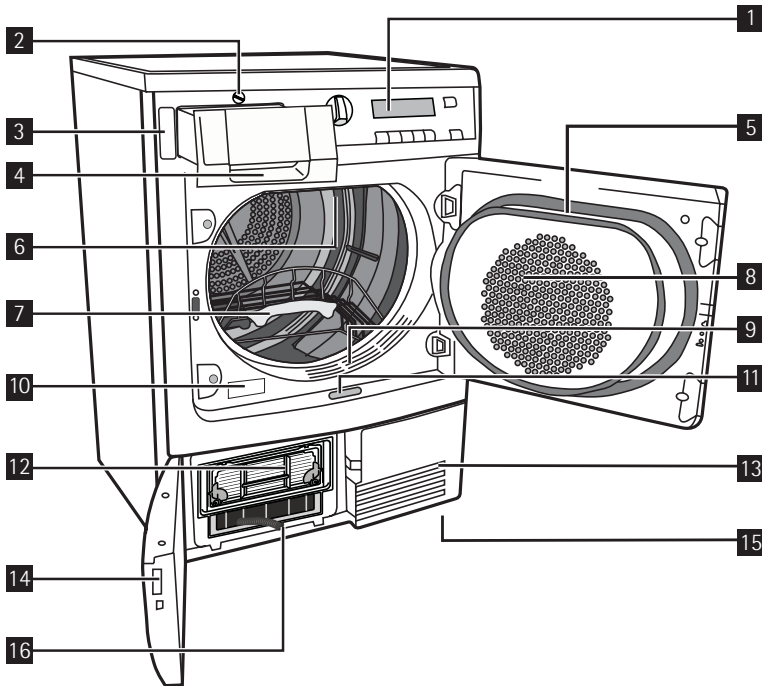

- 1** Control panel
- 2** Water recirculation valve/filter
- 3** Filler neck for steam water tank
- 4** Water reservoir
- 5** Fine fluff filters
- 6** Drum light
- 7** Drying rack
- 8** Loading door (reversible) / course fluff filters
- 9** Fluff filters
- 10** Rating plate
- 11** Button for opening door in plinth
- 12** Heat exchanger
- 13** Ventilation grille
- 14** Heat exchanger door
- 15** Adjustable feet
- 16** Drainage hose for water tank

Control panel

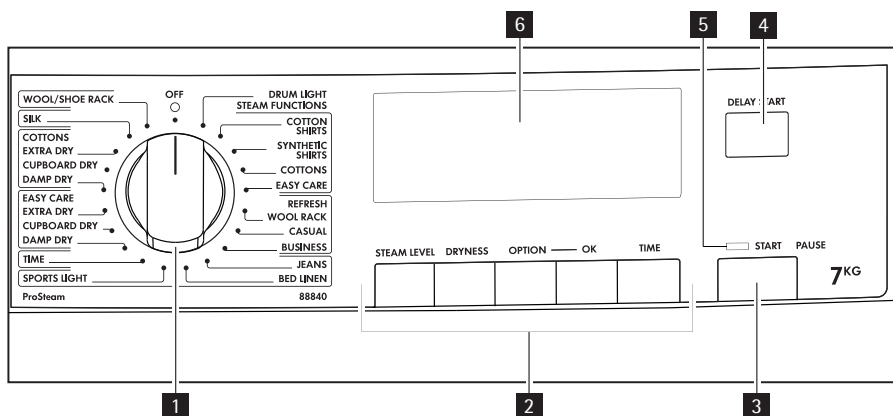

- 1 Programme knob and OFF switch
- 2 Function buttons
- 3 START PAUSE button
- 4 DELAY START button
- 5 Status LED
- 6 Display

Display

The display can show the following basic messages:

- 1 Currently set ProSteam or drying programme name and cycle duration.
- 2 Expected time of cycle end.
- 3 Option icon after option selection.
- 4 Visualisation of additional functions.



Every time a cycle is performed an animated progress bar is shown on the display indicating the status. In some cases you might also be guided and warned by displayed messages.



Display description

STEAM LOAD not selectable	minimal STEAM LOAD	medium STEAM LOAD	maximal STEAM LOAD

Display description			
DRYNESS not selectable	minimal DRYNESS	medium DRYNESS	maximal DRYNESS
SPIN SPEED not selectable	minimal SPIN SPEED	SPIN SPEED scope (100 rpm step)	maximal SPIN SPEED
BUZZER	DELICATE	LONG ANTI-CREASE	SENSITIVE
CHILD LOCK	cycle duration	cycle finish time	delay time

i The **DELICATE** and **SENSITIVE** options cannot be selected together

First start-up

Switching machine on / switching light on

Turn the programme selector to any programme or turn it to DRUM LIGHT. The machine has been switched on. When the loading door is opened, the drum light is illuminated.

Setting the language

Once the programme knob is set to any programme, e. g. COTTON SHIRTS, the display lights up and should look like the illustration opposite. The first time the appliance is used a brief introduction is activated in order to help you make the necessary introductory settings. Short help-text will change into the language setting view as soon as you press the OPTION or OK button.

If you want to keep the language: press the OK button.

If you want to change the language:

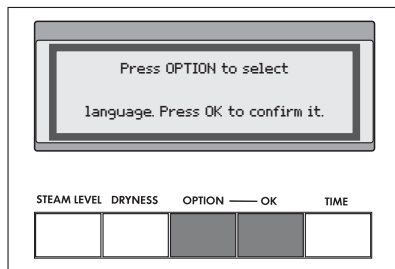

1. Press the OPTION button repeatedly, until the desired language appears in the display.
2. To confirm the choice press the OK button. After this a text appears asking you again to confirm the set language. This step is added to ensure that you did not set a language by mistake.

To confirm the choice press the OK button again.

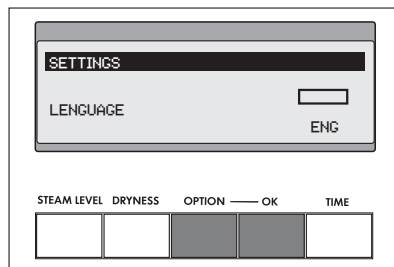

In case of a mistake or at any time after the first time use a short-cut is provided to avoid going through the SETTINGS. Keeping pressed together the buttons STEAM LEVEL and DRYNESS for about 5 seconds the language setting view appears.

Setting the time

Just after setting the language you are asked to set the time.

Short help-text will change into the time setting view as soon as you press the OPTION or OK button.

So that the time and the end of the programme are correctly displayed, please check the time shown in the display and set the current time if necessary.

To select the time please use the OPTION button to confirm press OK.

See also the chapter " SETTINGS".

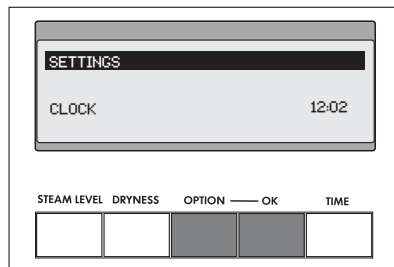
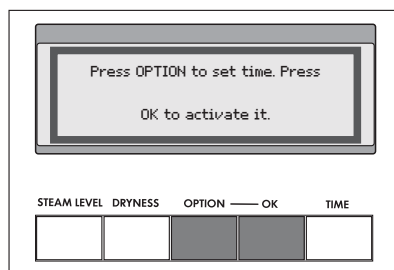

Before first use





In order to remove any residues which may have been produced during production, wipe the dryer drum with a damp cloth or carry out a brief drying cycle (30 MIN) with damp cloths in the machine.

1. Turn the programme knob to TIME.
2. Press the TIME button repeatedly until 30' appears in the display.
3. Press the START PAUSE button.

Sorting and preparing laundry

Sorting laundry

- Sort by fabric type:
 - Cotton/linen for programmes in *COTTONS* programme group.
 - Mixtures and synthetics for programmes in *SYNTHETICS* programme group.
- Sorting by care label. The care labels mean:

			
Drying in the tumble dryer possible in principle	Dry at normal temperature	Dry at reduced temperature (choose <i>DELICATE</i> option!)	Drying in the tumble dryer not possible

 Do not place in the appliance any wet laundry which is not specified on the care label as being suitable for tumble-drying.

This appliance can be used for all wet laundry items which are labelled as suitable for tumble-drying.

- Do not dry new, coloured textiles together with light-coloured laundry items. Textile colours may bleed.
- Do not dry cotton jersey and knitwear with the *EXTRA DRY* programme. Items may shrink!
- Wool and wool-like textiles can be dried using the *WOOL* programme. Before the drying cycle spin the woollen textiles as well as possible (max. 1200 rpm). Only dry woollen textiles together which are similar or the same with respect to material, colour and weight. Please dry heavy laundry items made of wool separately.



- The following textiles cannot be treated using a ProSteam programme: leather, textiles with large metal, wooden or plastic parts, textiles with rusting metal parts, oilskins or wax cotton garments.



- To smooth or freshen laundry with a ProSteam programme, sort laundry by size, weight, material and colour.
Only smooth textiles together that are similar in terms of size, weight, material and colour.



- Do not dry new, coloured textiles together with light-coloured laundry items. Colours may fade (check colour fastness of fabric when damp in an inconspicuous area).



- Do not use dry cleaning sets in combination with ProSteam programmes.

Preparing laundry

- To avoid laundry becoming tangled: close zips, button up duvet covers and tie loose ties or ribbons (e.g. of aprons).
- Empty pockets. Remove metal items (paper clips, safety pins, etc).
- Turn items with double-layered fabrics inside out (e.g. with cotton-lined anoraks, the cotton layer should be outermost). These fabrics will then dry better.

Special notes about ProSteam

- Before treating garments with a ProSteam programme, remove stains by washing or using localized stain removal

Laundry weights

Type of laundry	Weight
Bathrobe	1200 g
Napkin	100 g
Quilt cover	700 g
Sheet	500 g
Pillow case	200 g
Tablecloth	250 g
Towelling towel	200 g
Tea cloth	100 g
Night dress	200 g
Ladies' briefs	100 g
Man's work shirt	600 g
Man's work shirt	200 g
Man's pyjamas	500 g
Blouse	100 g
Men's underpants	100 g

Opening loading door / loading laundry

1. Open loading door:
Use force to push against the loading door (push point - see picture)
2. Load your laundry (do not force it in).
3. Close loading door securely. Lock must audibly lock.

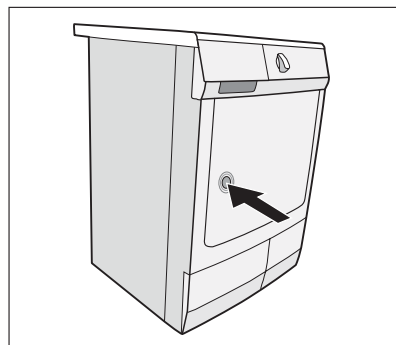

CAUTION!

Please ensure that laundry items do not get embedded between the loading door and the rubber seal.

ProSteam system

Fill steam water tank

You must fill up the steam water tank before using a ProSteam programme for the first time. Use the distilled water provided if there is not yet any condensed water from previous drying programmes (see chapter on 'Care and cleaning, Emptying condensed water container'). If, after a ProSteam programme is selected, the following message: *The steam water tank is empty. Please fill it and then press START* appears on the display, you will need to

fill up the steam water tank with distilled water. Otherwise, you will not be able to start any ProSteam programme.

Pull drawer containing condensed water container out a little **1**, then pull the water tank's filler neck **2**



Important! Only fill the water tank with distilled or fully desalinated water. Do not use tap water or additives! You can also use the condensed water from the tank, as long as you filter it first (use the canister supplied with the filter fitted: see picture opposite).

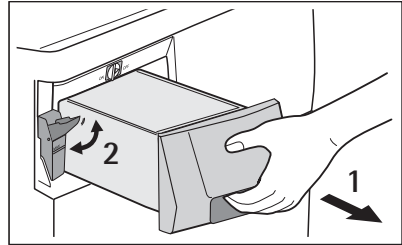

Fill with distilled water from the canister provided, up to the MAX mark inside the container. Push filler neck and drawer with condensed water container back in.

When dry, all textiles not specifically prohibited in the chapter 'Sorting and preparing laundry' may be treated with the ProSteam System. Wet textiles may only be treated if they are labelled as suitable for dry programmes.

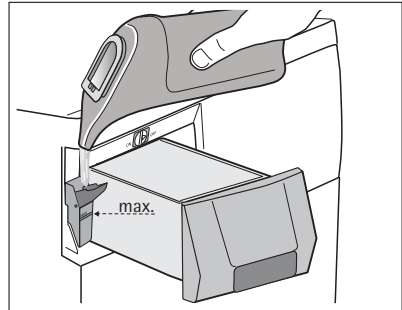

Water recirculation system

This system allows you to use for a ProSteam cycle the condensed water automatically collected in the condense water tank during a drying cycle.



The water in the condense water tank will never automatically fill the steam water tank. The water recirculation system works only if it is supplied by water arising during standard drying cycles.

To activate this system turn the valve to the ON position. When the valve is ON the steam water tank will be filled during the next drying cycle. Water will be supplied by the water circuit directly to the steam water tank filling it automatically.

To activate recirculation set valve to the ON position. To do that:

1. Pull drawer containing condensed water container out a little. Behind the drawer there are two elements:
 - 1** steam water inlet - for manual refilling of steam water container.
 - 2** water recirculation system valve/filter.

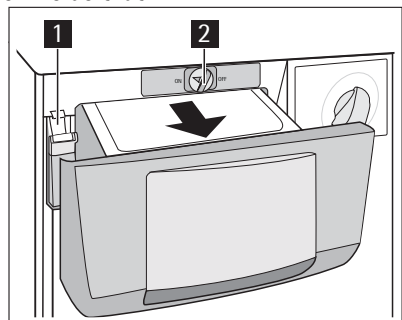

2. Turn the valve to the ON position. Water will be supplied by the water circuit directly to the steam water tank filling it automatically during the next drying cycle.

The steam water tank is empty. Please fill it and then press START



If valve is closed (OFF position) - recirculation system does not work.

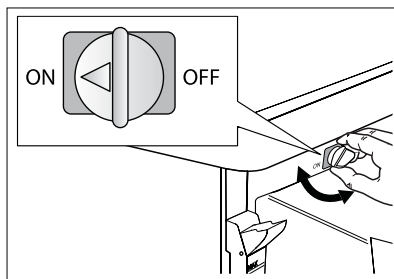

Overview of ProSteam programmes

Programmes	max. load (weight when dry)	Application/properties	
COTTON SHIRTS	1.0 kg	For 1- 5 cotton shirts. Min. 80% natural fibres (cotton, linen etc).	wet, dry
SYNTHETIC SHIRTS	1.0 kg	For 1- 5 synthetic shirts. Max. 20% natural fibres (cotton, linen etc).	wet, dry
COTTONS	3.0 kg	For smoothing cotton garments. Min. 80% natural fibres (cotton, linen etc).	wet, dry
EASY CARE	1.5 kg	For smoothing easy-care garments. Max. 20% natural fibres (cotton, linen etc).	wet, dry
WOOL REFRESH (rack) ¹⁾	1-2 items	For refresh and odour removal, up to two items. Only for dry garments. ^{2) 3)}	dry
CASUAL REFRESH	2.5 kg	For casual refresh like T-shirts, trousers, skirts etc. ^{2) 4)}	dry
BUSINESS REFRESH	2.5 kg	For suits, jacket suits and trousers refresh ²⁾	dry

1) only with drying rack installed

2) SPIN SPEED not selectable

3) LONG ANTI-CREASE not selectable

4) for more details refer to Textile Guide leaflet.



All information on applications is for guidance only. Smoothing results may vary depending on the selected programme and especially the fittings and material properties of the textile. The results can be improved if necessary by using different programmes and steam volumes. For example, some textiles containing more than 20% synthetic but with the right fittings may behave more like cotton textiles in a ProSteam programme. You may therefore get better smoothing results by selecting a cotton ProSteam programme.



Given the wide range of different textile grades and properties that can be manufactured today using different mechanical and chemical processes, we recommend running the first few ProSteam programmes at low steam levels and with a small number of garments that are as similar as possible. Later, you can carefully start to vary the conditions of ProSteam programmes to learn from experience how to get the best results from the volume of laundry loaded, the quality of the textiles and the most suitable steam levels and ProSteam programmes. Please also note the accompanying "Textile Guide".

Programme	STEAM LEVEL	Loading volume	Duration dry [min.] ¹⁾	Duration wet [min.] ¹⁾
COTTON SHIRTS	MIN	1 - 2 items	19	40 +/-10
	MED	3 - 4 items	21	
	MAX	5 items	22	
SYNTHETIC SHIRTS	MIN	1 - 2 items	13	30 +/-5
	MED	3 - 4 items	14	
	MAX	5 items	16	
COTTONS	MIN	0.5 - 1 kg	12	40 +/-10
	MED	1 - 2 kg	13	
	MAX	2 - 3 kg	15	
EASY CARE	MIN	0,2 - 0,5 kg	12	30 +/-5
	MED	0.5 - 1 kg	13	
	MAX	1 - 1.5 kg	15	
WOOL REFRESH (rack) ¹⁾	MIN	1 item	15	-
	MED	1- 2 items	16	-
	MAX	2 items	19	-
CASUAL REFRESH	MIN	1- 2 items	18	-
	MED	3- 4 items	18	-
	MAX	5 items	19	-
BUSINESS REFRESH	MIN	1 pair of trousers	12	-
	MED	1 jacket	13	-
	MAX	1 suit	15	-

1) exact programme times appear in the display once the machine has performed wet/dry recognition (approx. 2 min.)



All information provided on selecting the steam level and corresponding load are suggestions only. In some cases, using a higher steam level or smaller load may give better results. The refresh programmes are gentle ProSteam programmes for non-washable textiles. Any distortion to the shape of a garment which might occur in few cases, can be remedied by ironing.

Selecting the programme

Use the programme selector to set the programme you require. The estimated programme duration (in hours and minutes) appears in the multi-display as well as cycle finish time.

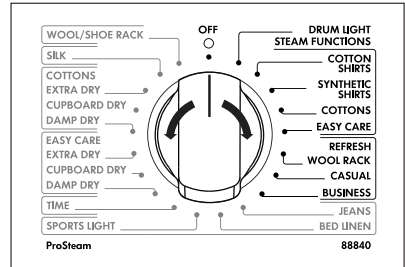

Select STEAM LEVEL

To achieve the best results, different steam levels are required for different volumes of laundry.

The STEAM LEVEL button is used to set the required steam quantity of: MIN, MED or MAX.

All ProSteam programmes, apart from the REFRESH programmes, automatically recognize the remaining dampness in clothes. When laundry is wet, a drying cycle is activated first if required. The table shows the steam levels appropriate for the selected load, under STEAM LEVEL.

Press the STEAM LEVEL button repeatedly until the desired steam level (MIN, MED or MAX) is shown in the display.

If the STEAM LEVEL button is not pressed after a ProSteam programme is selected, the medium steam level (MED) is selected automatically. If you select a REFRESH programme, MIN is selected automatically.



If in doubt, always select a lower steam level first until you have more experience with load volumes, fabric types and the corresponding optimum steam level. If too high steam level is selected, garments may lose their shape. If too low steam level is selected, creases may remain.

Selecting additional options

The additional options available for the ProSteam programmes are LONG ANTICREASE, BUZZER, SPIN SPEED¹⁾ and the CHILD LOCK.

1. By turning the knob choose a ProSteam programme.
2. To set the option press OPTION button. You will see available options on the screen.
3. Press repeatedly OPTION button to select proper option. Selection is marked by rectangular border.
4. Press OK button to activate it. Suitable icon should appear on the right side of the screen.



To deselect an option follow the same steps. Option icon should disappear.

1) available with cotton/easy care and cotton/synthetic shirts programmes

LONG ANTICREASE

A 90 minute anti-crease phase is set. The display now shows the long anti-crease  icon. If this additional option is selected, the anti-crease phase (30 min.) at the end of the ProSteam cycle is lengthened by 60 minutes. The laundry can be removed at any time during the anti-crease phase.

BUZZER

The appliance is supplied with the BUZZER function deactivated. The button is used to switch the function on or off. When the function is active, the BUZZER symbol appears in the display.

The buzzer sounds or plays a tune during:

- cycle end
- anti-crease phase and when phase starts or ends
- cycle interruption by a warning
- alarm

CHILD LOCK

The child lock can be set to prevent a programme being accidentally started or a programme in operation being accidentally changed. The child safety device locks all buttons and the programme knob. The child safety device can be deactivated by holding down the OPTION and OK buttons simultaneously for 5 seconds.

- Before programme is started: appliance cannot be used
 - After programme is started: programme in operation cannot be changed
- The child lock  icon appears in the display to indicate that the child lock is activated. The child lock is not deactivated once the programme comes to an end. If you want to set a new programme, you must first deactivate the child lock.

SPIN SPEED

If the washing in the washing machine was initially drained prior to the ProSteam cycle, the dryer can be set according to the spin speed of the initial drainage procedure. The higher the spin speed was, the shorter the programme length for the drying cycle.

Activate the SPIN SPEED option and then number of times press OPTION button until the desired spin speed of the initial drainage is displayed. No value is shown if no spin speed is selected.

In certain programmes the spin speed has **not** effect (time controlled cycles), its selection **can be not selectable** and only three dashes are visualized. Available selections: from 800 to 1800 rpm's in 100 rpm's intervals.

The maximum value depends **by** selected program, the minimum is always 800 rpm

For those programs where the spin speed has no effect (time controlled cycles), the selection is not allowed and three dashes "- - -" are displayed that has the meaning of not set or unknown.

The user interface **always remembers** last spin selection, and proposes it as default for all new selected programs. If memorized spin speed is greater than maximum allowed value it will be automatically reduced to max spin speed available for the selected program.

Setting DELAY function



With the DELAY button, you can delay the start of a ProSteam programme by between 30 minutes and a maximum of 20 hours.

1. Select the programme and additional functions/options if necessary.
2. Press the DELAY button as many times as necessary.

During selection, END TIME of the cycle increases in the display and delay icon ⌚ is on.

i If you reach 20 hours of start delay and you press the button again, the time delay is cancelled and delay icon disappears.

3. To activate the delay timer, press the START PAUSE button. The amount of time remaining until the programme is set to start is continuously displayed (e.g. 5:00 hours, 4:59... 0:30 minutes etc).

The message *Delay Start* and delay icon ⌚ is on.

Starting the ProSteam programme

Press the START PAUSE button. The programme starts.

The progress bar and the name of currently performed phase, above it, show stage of the cycle. With wet laundry, after a few minutes the appliance will show the correct programme duration for the ProSteam programme including the preceding drying programme.

As soon as the right level of dryness is reached, the ProSteam programme will start automatically. Alternately *Steam Treatment* and *Steam Injection* phases names are displayed.



! During the steam phases that form part of the ProSteam programme and also the anti-crease phase the loading door cannot be opened.
Risk of burns!

If the steam water tank is empty when you select a ProSteam programme the following message will appear on the display (see picture). The programme cannot be started. You will need to fill the water tank first (see chapter *ProSteam system* - section *Filling steam water tank*)

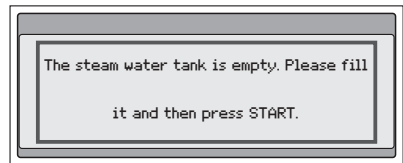

i It is normal for the appliance to make noises during a ProSteam or drying programme if garments with hard parts, such as metal buttons, are put in the drum.

Changing a programme

To change a programme which has been selected by mistake once the programme has started, first turn the programme selector to OFF and then reset the programme.

i The programme can no longer be changed directly once the programme has started. If you nevertheless attempt to change the programme with the programme knob the following message is shown:

Please turn programme selector to the last used position.

The drying programme is not however affected by this.

Putting in extra items or taking items out before end of programme

1. Open loading door.



WARNING!

Laundry and drum can become hot. **Risk of burns!**

2. Load or remove laundry items.
3. Close loading securely. Lock must audibly lock.
4. Press the START PAUSE button to continue the drying cycle.

ProSteam programme complete / removing laundry

After the ProSteam cycle is completed, 0:00 starts flashing and alternatively the messages: *Finished. Please remove the laundry* and *Anti-crease* appear in the display. If the buzzer has been activated, an audible signal sounds at regular intervals.



The ProSteam programme is automatically followed by an anti-crease phase, including brief steam phases, which lasts around 30 minutes.

The drum rotates during the anti-crease phase. This keeps the laundry loose and free of creases. It can be removed at any time during the anti-crease phase, except during steam injection phases (look for *Steam Injection* message in the display !). Laundry should be removed as quickly as possible.

1. Open the loading door to remove the laundry.
2. Before removing the laundry, remove fluff from the micro-fine filter. It is best to use a damp hand for this purpose. (See "Care and cleaning" chapter.)
3. Remove laundry one garment at a time.



To retain the effects of the ProSteam treatment, clothes must be removed one garment at a time during the anti-crease phase and hung immediately on a clothes hanger to dry (for at least 5-15 mins, depending on fabric and selected steam level). Do up the buttons and tug the garment into shape, paying particular attention to cuffs and seams.

4. Turn the programme knob to OFF.



After each drying cycle

- Clean the micro-fine filter and fine filter
 - Drain the condensed water container if you do not use water recirculation system (See chapter "Care and Cleaning".)
5. Close door.

Drying

Drying programmes overview

Programme	max. load (weight when dry)	Application/properties	Care mark
COTTONS			
EXTRA DRY	7 kg	Thorough drying of thick or multi-layered fabrics, e.g. terry towel- ling items, bathrobes.	
CUPBOARD DRY	7 kg	Thorough drying of fabrics of even thicknesses, e.g. terry towelling items, knitwear, towels.	
DAMP	7 kg	For normal thickness cotton or linen laundry, e.g. bedding, table linen.	
SYNTHETICS			
EXTRA DRY	3 kg	Thorough drying of thick or multi-layered fabrics, e.g. pullovers, bedding, table linen.	
CUPBOARD DRY	3 kg	For thin fabrics which are not ironed, e.g. easy care shirts, table linen, baby clothes, socks, lingerie with bones or wires.	
DAMP	3 kg	For thin fabrics which are also to be ironed, e.g. knitwear, shirts.	
TIMED PRO- GRAMME	7 kg	For further drying of individual items of laundry. Press the TIME button to set the cycle duration (scope 30-180 min.). ^{2) 3) 4)}	
SPORTS LIGHT	2 kg	For sportswear, thin fabrics, polyester, which are not ironed. ^{5) 4)}	
BED-LINEN	3 kg	Bed linen (single and double sheet, pillowcase, bedspread, duvet cover).	
JEANS	7 kg	For leisure clothing, such as jeans, sweat-shirts, etc., of different material thicknesses (e.g. at the neck, cuffs and seams).	

Programme	max. load (weight when dry)	Application/properties	Care mark
SILK	1 kg	For drying silk using warm air and gentle movement. ^{3) 5) 4)}	
WOOL / SHOE RACK	1 kg	For drying woollen fabrics after they have been washed, using warm air at minimum mechanical load (Follow section "Sorting and preparing washing"). Recommendation: Remove fabrics immediately after drying, as no anti-crease programme follows. / For gentle drying of one pair of sport shoes, washed and spin-dried at 1000 rpm. Programme run times: between 30 and 180 minutes. Press the TIME button to set the cycle duration (scope 30-180 min.) 2) 3) 5) 4)6)	

- 1) select DELICATE
- 2) DRYNESS not selectable
- 3) SPIN SPEED not selectable
- 4) SENSITIVE not selectable
- 5) DELICATE set as default
- 6) LONG ANTI-CREASE not selectable



Option DELICATE and SENSITIVE cannot be selected together

Selecting the programme

Use the programme selector to set the programme you require. The estimated programme duration (in hours and minutes) appears in the multi-display as well as cycle finish time.

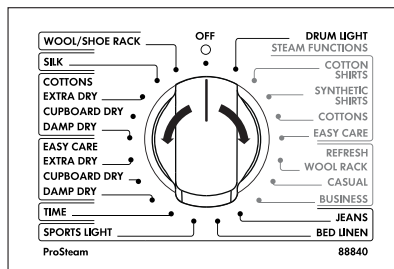

Setting DRYNESS

This function improves the dryness of the laundry. Laundry becomes drier as you move from **MIN** to **MAX**.

Press the DRYNESS button repeatedly until the desired dryness level (**MIN**, **MED** or **MAX**) is shown in the display. When humidity adjustment is not foreseen on the related program, message *Not Selectable* is shown.

If wool or silk comes out of the machine too damp at the end of a WOOL or SILK programme, you can dry it again by restarting the appropriate programme, this time with the DRYNESS function selected and dryness level **MIN**, **MED** or **MAX**. In the case of a drying cycle with relatively dry laundry, the end of the programme cycle displayed at the beginning is corrected after a while.

**CAUTION!**

Make sure that by selecting the DRYNESS function, you do not over-dry your wool or silk.

Selecting additional options

The additional options available for the drying programmes are DELICATE, SENSITIVE, LONG ANTICREASE, BUZZER, SPIN SPEED²⁾ and the CHILD LOCK.

1. By turning the knob choose a drying programme.
2. To set the option press OPTION button. You will see available options on the screen.
3. Press repeatedly OPTION button to select proper option. Selection is marked by rectangular border.
4. Press OK button to activate it. Suitable icon should appear on the right side of the screen.



To deselect an option follow the same steps. Option icon should disappear.

DELICATE

For especially gentle drying of sensitive fabrics with the care label:  and for temperature-sensitive textiles (e.g. acrylic, viscose). Programme is executed with reduced heat.

DELICATE is only suitable for use with loads of up to 3kg.

When the option is active, the DELICATE  icon is on.

SENSITIVE

For gentle drying of fabrics that are frequently worn. Programme starts on full heat setting, which is then reduced as the programme progresses to be kind to the washing.

When the option is active, the SENSITIVE  icon is on.

LONG ANTICREASE

A 90 minute anti-crease phase is set. The display now shows the long anti-crease  icon. If this additional option is selected, the anti-crease phase (30 min.) at the end of the drying cycle is lengthened by 60 minutes. The laundry can be removed at any time during the anti-crease phase.

BUZZER

The appliance is supplied with the BUZZER function deactivated. The button is used to switch the function on or off. When the function is active, the BUZZER symbol appears in the display.

The buzzer sounds or plays a tune during:

- cycle end
- anti-crease phase and when phase starts or ends
- cycle interruption by a warning
- alarm

CHILD LOCK

The child lock can be set to prevent a programme being accidentally started or a programme in operation being accidentally changed. The child safety device locks all buttons and the programme knob. The child safety device can be deactivated by holding down the OPTION and OK buttons simultaneously for 5 seconds.

2) available with cotton/easy care and cotton/synthetic shirts programmes

- Before programme is started: appliance cannot be used
 - After programme is started: programme in operation cannot be changed
- The child lock  icon appears in the display to indicate that the child lock is activated. The child lock is not deactivated once the programme comes to an end. If you want to set a new programme, you must first deactivate the child lock.

SPIN SPEED

If the washing in the washing machine was initially drained prior to the drying cycle, the dryer can be set according to the spin speed of the initial drainage procedure. The higher the spin speed was, the shorter the programme length for the drying cycle.

Activate the SPIN SPEED option and then number of times press OPTION button until the desired spin speed of the initial drainage is displayed. No value is shown if no spin speed is selected.

In certain programmes the spin speed has **no** effect (time controlled cycles), its selection is not possible and only three dashes are visualised. Available selections: from 800 to 1800 rpm's in 100 rpm's intervals.

The maximum value depends on the selected program, the minimum is always 800 rpm. For those programs where the spin speed has no effect (time controlled cycles), the selection is not allowed and three dashes " - - - " are displayed that has the meaning of not set or unknown.

The user interface always stores the last spin selection, and proposes it as default for all new selected programs. If memorised spin speed is greater than maximum allowed value it will be automatically reduced to max spin speed available for the selected program.

Selecting TIME

To select the programme duration after setting the TIME programme. You can select a programme duration from 10 minutes to 3 hours in 10-minute steps.

1. Turn the programme knob to the TIMED PROGRAMME. The 0:10 minutes is in the display (corresponding to the cooling phase).
2. Press the TIME button repeatedly until the desired programme duration is shown in the display, e.g. 0:20 for a programme of 20 minutes.

If the programme duration is not selected, the duration is automatically set to 10 mins.

Selecting DELAY START

See chapter *ProSteam system*, section *Selecting DELAY START*.

Starting the drying programme

Press the **START PAUSE** button. The programme starts.

The progress bar and the name of currently performed phase, above it, show stage of the cycle.

With wet laundry, after a few minutes the appliance will show the correct programme duration and foreseen time of cycle end.



It is normal for the appliance to make noises during drying programme if garments with hard parts, such as metal buttons, are put in the drum.

Changing a programme

To change a programme which has been selected by mistake once the programme has started, first turn the programme selector to OFF and then reset the programme.

 **The programme can no longer be changed directly once the programme has started. If you nevertheless attempt to change the programme with the programme knob the following message is shown:**

Please turn programme selector to the last used position.

The drying programme is not however affected by this.

Putting in extra items or taking items out before end of programme

1. Open loading door.



WARNING!

Laundry and drum can become hot. **Risk of burns!**

2. Load or remove laundry items.
3. Close loading securely. Lock must audibly lock.
4. Press the START PAUSE button to continue the drying cycle.

Drying programme complete / removing laundry

After the drying cycle is completed, 0:00 starts flashing and alternatively the messages: *Finished. Please remove the laundry* and *Anti-crease* appear in the display. If the buzzer has been activated, an audible signal sounds at regular intervals.

 **The drying programme is automatically followed by an anti-crease phase, including brief steam phases, which lasts around 30 minutes.**

The drum rotates during the anti-crease phase. This keeps the laundry loose and free of creases. It can be removed at any time during the anti-crease phase. Laundry should be removed as quickly as possible to prevent creases from forming.

1. Open the loading door to remove the laundry.
2. Before removing the laundry, remove fluff from the micro-fine filter. It is best to use a damp hand for this purpose. (See "Care and cleaning" chapter.)
3. Remove laundry.
4. Turn the programme knob to OFF.



After each drying cycle

- Clean the micro-fine filter and fine filter
 - Drain the condensed water container (See chapter "Care and Cleaning".)
5. Close door.

Drying rack

The drying rack offers the possibility of drying washable woollen fabrics and sports shoes. The drying rack does not turn with the clothes-dryer drum. This allows the drying of woollen garments or sports shoes.

When wet, the wool must be moved as little as possible because it tends to become matted, so drying rack is a solution.

Sports shoes cannot be dried without the rack, they can damage the drum due to their weight.



For first unpacking of the rack please refer to the installation chapter.



WARNING!

Before installing the rack check the dryer drum. It must be empty!

1. Open the loading door.
2. Insert the rack.

Lift the rack horizontally in the drum.
Guide the rack down until the support
bracket at the front rests on the opening.

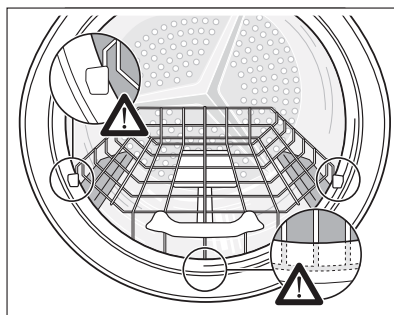

3. Place the washing on the rack:
 - Spread the garment out in the rack and roll it up, without squashing or folding it.
 - Place sport shoes on the rack with the handle turned up as a support.

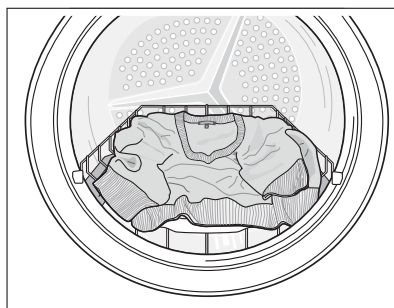

Take out the insoles and place them beside the shoes on the rack. Tie the shoelaces.

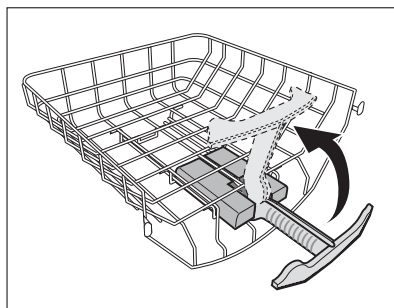

4. Select the required programme run time, selectable with an interval of 10 min, from 30 min. up to 180 minutes.

Press the TIME button as many times as necessary until the required programme running time is shown in the display.

5. Press the START PAUSE button. The programme is started.
6. At the end of the drying programme open the loading door and remove the garments or shoes.
7. Turn the programme selector to OFF.
8. Remove the rack from the drum at the end of drying.

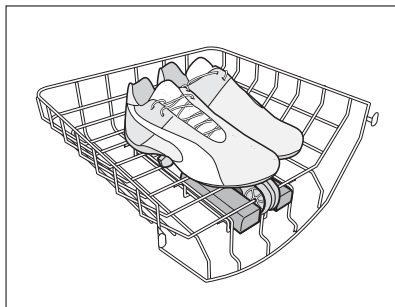

Care and cleaning

Cleaning fluff filter

The filters collect all the fluff which accumulates during drying. To ensure that the dryer works perfectly, the fluff filters (micro-fine filter and fine strainer) must be cleaned after every drying cycle.

The message *Please clean the filters.* is shown in the display to remind you this operation.



CAUTION!

Never operate the dryer without fluff filters or with damaged or blocked fluff filters.

1. Open loading door
2. Use a damp hand to clean the micro-fine filter, which is built into the lower part of the loading aperture.

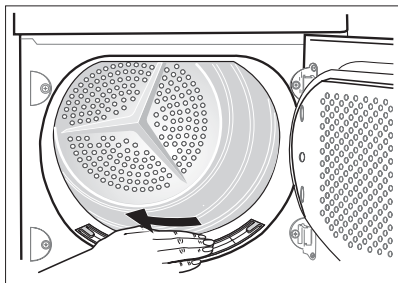

3. After a period of time, a patina due to detergent residue on laundry forms on the filters. When this occurs, clean the filters with warm water using a brush. Remove the filter from the door pulling it out. It can be positioned with the tooth facing to the left or to the right).

After cleaning do not forget to put it back.

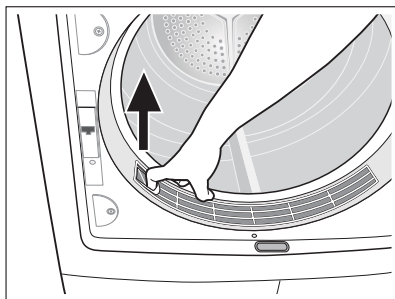

4. Push down unlock button on large mesh filter.
Large mesh filter jumps up.

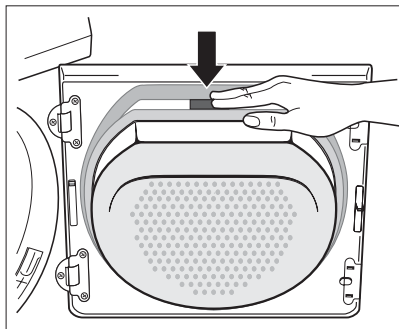

5. Take out fine strainer.
6. Remove fluff from fine strainer. It is best to use a damp hand for this purpose.

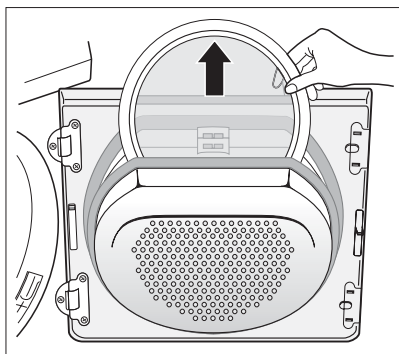

Clean the entire filter area

The strainer area does not have to be cleaned after every drying cycle, but should be checked regularly and cleaned of fluff if necessary.

7. To do this, grip the top of the large mesh filter and pull it forwards until it comes loose from the two brackets.
8. Remove fluff from the entire filter area. It is best to use a vacuum cleaner for this purpose.
9. Press both journals of the large mesh filter into the brackets on the loading door until they snap into place.
10. Re-insert fine strainer.
11. Press against the large mesh filter until it locks into the interlock.

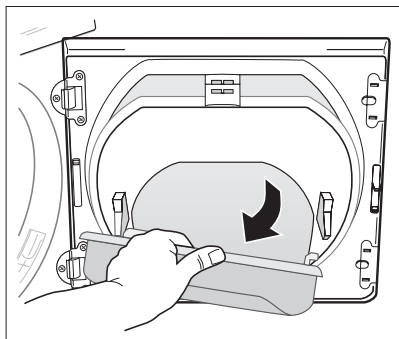



If the fine strainer is not fitted, the large mesh filter will not snap into place and the loading door cannot be closed.

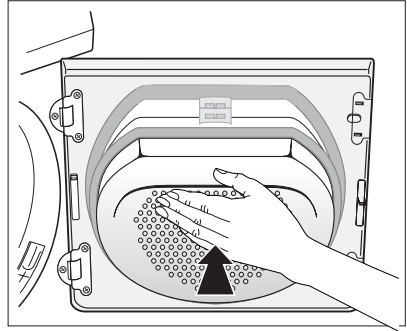

Cleaning the door seal

Wipe the door seal with a damp cloth immediately after the drying cycle has finished.

Emptying the condensate tank

Empty condensed water container after every drying cycle.



- Emptying of condensate water tank can be limited or fully eliminated in case of:
- open recirculation system if you use Pro Steam programmes (See section *Water recirculation system*)
 - direct drain system installation (See section *Special accessories*)

If the condensate tank is full, an active programme will break off automatically and the message *The tank is full. Please empty it and then press START.* is shown in the display. In order to continue the programme, the condensate tank must first be emptied.



WARNING!

The condensate is not suitable for drinking or for preparing foodstuffs.

1. Take out drawer containing condensed water container completely **1** and pull up the condensed water container's drainage pipe as far as it will go **2**.

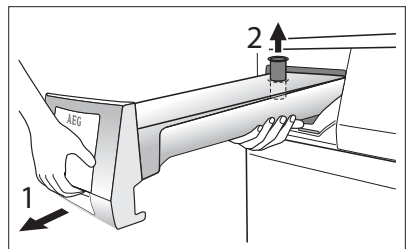

2. Pour condensed water out into a basin or similar receptacle.
3. Slide outlet connections in and refit condensate tank.

If the programme has been interrupted as a result of the condensate tank being full: Press the START PAUSE button to continue the drying cycle.

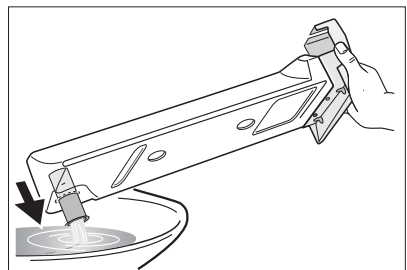

i The condensate tank has a volume of approx. 4 litres. This is sufficient for around 7 kg of laundry which has previously been spun at 1000 revolutions/ minute.

- The condensed water can be used as distilled water, e.g. for steam programmes. However, first filter the condensed water to remove any residues and small pieces of fluff.

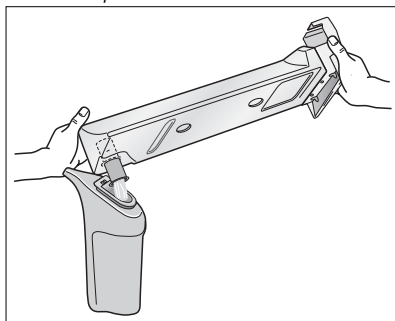

i Using the attached canister to filter: Pour the water out of the container straight through the filter at the top of the canister.

Cleaning heat exchanger

If the message: *Please clean the condenser* is shown in the display, the heat exchanger needs to be cleaned.



CAUTION!

Operating when the heat exchanger is blocked with fluff can damage the dryer. This also increases energy consumption.

- Open door.
- Open door in plinth. To do this, press the release button on the bottom of the door aperture and open the door in the plinth to the left.
- Clean fluff from the inside of the door and the heat exchanger front chamber. Wipe the door seal with a damp cloth.

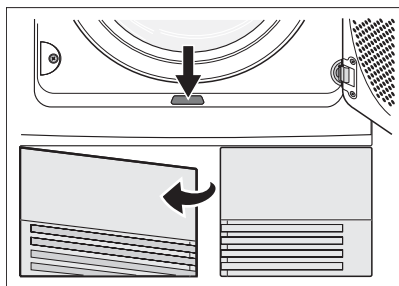

- Turn both lock washers inwards.

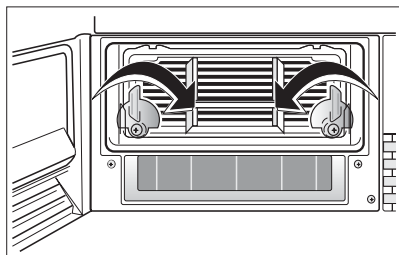

5. Use the handle to pull the heat exchanger out of the base and carry it horizontally to prevent any remaining water from spilling.
6. To empty the heat exchanger, hold vertically over a washing-up bowl.

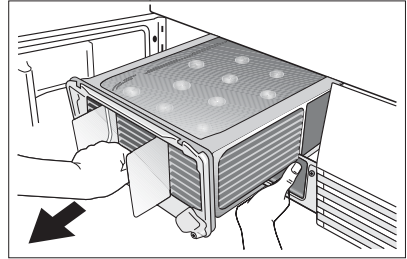

CAUTION!

Do not use sharp objects to clean. The heat exchanger could develop leaks.

7. Clean heat exchanger.

It is best to use a brush or to rinse thoroughly with a hand-held shower.

8. Replace heat exchanger and lock into place (turn both lock washers outwards until they snap into place).
9. Close door in plinth.



CAUTION!

Never operate the dryer without the heat exchanger.

Cleaning the water recirculation valve/filter

If the message: *Please clean the water recirculation filter* is shown in the display, the recirculation filter needs to be cleaned. The valve/filter is placed behind the tank handle - see chapter "Product description".

1. Pull out completely the drawer containing condensed water container.
2. Turn the valve/filter to the **OFF** position.
3. Wait a few seconds to allow the correct emptying of the valve/filter.
4. Pull out the valve/filter.
5. Clean the valve/filter under warm water.
6. Re-insert the valve/filter.
7. Turn the valve/filter to the **ON** position.

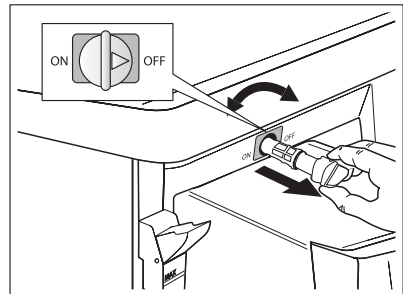

Cleaning the drum



CAUTION!

Do not use abrasives or steel wool to clean the drum.



Lime in the water or cleaning agents may form a barely visible lining on the inside of the drum. The degree to which the laundry has been dried is then no longer detected reliably. The laundry is damper than expected when removed from the dryer. Use a standard domestic cleaner (e.g. vinegar-based cleaner) to wipe down the inside of the drum and drum ribs.

Clean operating screen and housing



CAUTION!

Do not use furniture cleaners or aggressive cleaning agents to clean the machine. Use a damp cloth to wipe down the operating screen and housing.

What to do if ...

Troubleshooting by yourself

If, during operation, the warning message appears on the LCD follow strictly guides included in the message on the display. If you are not able to solve the problem, please inform your local service force centre.

Problem	Possible cause	Remedy
Dryer does not work.	Mains plug is not plugged in or fuse is not working correctly.	Plug in at mains socket. Check fuse in fuse box (domestic installation).
	Loading door is open.	Close loading door.
	Have you pressed the START PAUSE button?	Press the START PAUSE button again.
ProSteam programme does not start. Message on the display: <i>The steam water tank is empty. Please fill it and then press START.</i>	Water tank is empty.	Fill water tank.
	Recirculation valve is closed (OFF position)	Turn the recirculation valve to ON position.
After a ProSteam programme, garments are not sufficiently smooth.	Wrong programme selected (e.g. SYNTHETICS instead of COTTON).	Note the composition of the fabric.
	Too low a steam level set.	Set a higher steam level.
	Too many garments in machine, or garments that are too different.	Load the machine with fewer garments, or only similar ones.
	Clothes are not removed until the anti-crease phase is finished.	Remove clothes quickly one at a time from the machine as soon as possible after the start of the anti-crease phase.
	Garments not hung on clothes hangers and/or not tugged into shape.	Hang garments on clothes hangers, do up buttons and tug garments into shape.
	Multi-layered garments tend to lose their shape.	Reshape multi-layered garments by ironing after they come out of the machine.
After a ProSteam programme, there are no creases left in the garments.	The ProSteam programme has the effect of smoothing garments.	Iron creases in again after the ProSteam programme.

Drying results unsatisfactory.	Wrong programme selected.	Select a different programme the next time you dry (see "Programme chart" chapter).
	Lint filters clogged.	Clean lint filters.
	Fluff filter clogged.	Clean fluff filter.
	Heat exchanger clogged with lint.	Clean heat exchanger.
	Overloading of laundry.	Observe recommended loading volumes.
	Ventilation slots in base area covered up.	Uncover ventilation slots in base area.
	Residue on inside surface of drum or drum ribs.	Clean inside surface of drum and drum ribs.
		Make an adjustment using the DRYNESS function (see chapter "Drying")
Conductance of water at installation site differs from standard setting of machine.	Re-programme standard setting for degree of drying (see 'Programming options' chapter).	
<p>Loading door does not close.</p> <p>Message on the display: <i>Please check if the door is closed properly and then press START.</i></p>	Fine strainer not in place and/or mesh filter not locked in place.	Install fine strainer and/or snap large mesh filter into place.
When a button is pressed – no reaction of the machine.	Drying protection. After the start of the programme, the option can no longer be set.	Turn the programme knob to OFF. Set the programme again.
Drum light does not work.	Programme selector in OFF position.	Turn programme selector to DRUM LIGHT or to any programme.
	Defective light bulb.	Replace light bulb (see next section).
Displayed programme time changes erratically or stays unchanged for a long time.	Programme time is corrected automatically depending on type and volume of laundry and level of dampness.	Automatic process; this is not a machine fault.
<p>Programme inactive, messages: <i>The tank is full. Please empty it and then press START or Please empty the tank.</i> are displayed.</p>	Condensate tank is full.	Empty condensate tank, then start programme with START PAUSE button.
Drying cycle ends shortly after programme starts. <i>Finished</i> message is displayed.	Not enough washing loaded or washing loaded is too dry for selected programme.	Select time programme or higher drying level (e.g. CUPBOARD DRY instead of DAMP).

Drying cycle lasts an unusually long time. Note: After around 5 hours the drying cycle ends automatically (see „Drying cycle complete“).	Lint filter clogged.	Clean lint filter.
	Fluff filter clogged.	Clean fluff filter.
	Load volume too big.	Reduce load volume.
	Laundry insufficiently spun.	Laundry must be adequately spun.
	Particularly high room temperature.	Automatic process, there is no fault with the appliance. If possible, lower the room temperature.
Discolouration	Colour fastness of textiles.	Check colour fastness of textiles. Only treat textiles together if they are a similar colour.

Changing the bulb for interior lighting

Only use a special bulb which is designed specially for dryers. The special bulb can be obtained from your local service centre.



When the appliance is switched on, the interior lighting switches itself off after 4 minutes when the door is open.



WARNING!

Do not use standard bulbs! These develop too much heat and may damage the machine! Before replacing the bulb, disconnect the mains plug; with a permanent connection: fully unscrew or deactivate the fuse.

1. Unscrew cover above the bulb (this can be found directly behind the loading aperture, at the top; refer to "Description of machine" section.)
2. Replace defective bulb.
3. Screw cover back down.

Check the correct positioning of o-ring gasket before screwing back the door light cover. Do not operate the dryer when missing o-ring gasket on door light cover.



WARNING!

For safety reasons, the cover must be screwed down tightly. If this is not done, the dryer must not be operated.

SETTINGS

The special options that can be set under SETTINGS remain permanently stored independent of each drying cycle – even after the appliance has been switched off or the mains plug has been removed from the socket.

To enter the settings:

1. Press OPTION button repeatedly until selection frame marks SETTINGS.
2. Press OK button to confirm.
3. Use OPTION button to scroll through the list.

After few seconds of inaction settings view comes back to main view.

You can get back to previous view each time if you select Back and confirm OK.

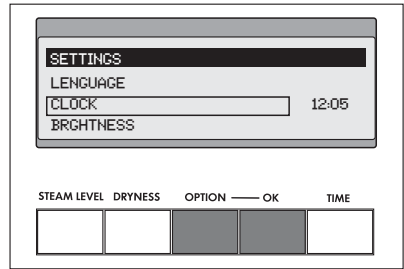

LANGUAGE

Language setting is always first as a default.

1. Press OK button - frame above language abbreviation starts blinking.
2. Press OPTION button until you set requested language.
3. Press OK to confirm.

TIME

1. Press OPTION button until TIME selected.
2. Press OK to confirm - hour indication starts blinking.
3. Press OPTION until you set the right hour.
4. Press OK to confirm - minutes indication starts blinking.
5. Press OPTION until you set right minutes.
6. Press OK to confirm.

BRIGHTNESS

1. Press OPTION button until BRIGHTNESS selected.
2. Press OK to confirm - frame around bar indicator starts blinking.
3. Press OPTION until you set right brightness level.
4. Press OK to confirm.

CONTRAST

1. Press OPTION button until CONTRAST selected.
2. Press OK to confirm - frame around bar indicator starts blinking.
3. Press OPTION until you set right contrast level.
4. Press OK to confirm.

WATER HARDNESS

i Water contains, a variable quantity of limestone and mineral salts of which quantities vary according to geographical locations thus varying its conductivity values. Relevant variations of the conductivity of the water compared to those prefixed by the factory could slightly influence the residual humidity of the laundry at the end of the cycle. Your dryer allows you to regulate the sensitivity of the drying sensor based on conductivity values of the water.

1. Press OPTION button until WATER HARDNESS selected.
2. Press OK to confirm - frame around bar indicator starts blinking.
3. Press OPTION until you set right hardness level.
4. Press OK to confirm.

i available selections:

- **MIN** - low conductivity $<300 \mu\text{S/cm}$
- **MED** - medium conductivity $300-600 \mu\text{S/cm}$
- **MAX** - high conductivity $>600 \mu\text{S/cm}$

i **MED** is set as default.

FULL TANK WARNING - ON/OFF

i The container indicator at the end of the programme can be deactivated, for example, if an external condensed water drain is installed.

1. Press OPTION button until FULL TANK WARNING selected.
2. Press OK to confirm - frame around bar indicator starts blinking.
3. Press OPTION until you set right status.
4. Press OK to confirm.

i Warning is set to ON as default.

Technical data



This appliance conforms with the following EU Directives:

- 2006/95/EC dated 12.12.2006 Low Voltage Directive
- 89/336/EEC dated 03.05.1989 EMC Directive inclusive of Amending Directive 92/31/EEC
- 93/68/EEC dated 22.07.1993 CE Marking Directive

Height x width x depth	85 x 60 x 58 cm
Drum volume	108 l
Depth with loading door open	109 cm
Height can be adjusted by	1.5 cm
Weight when empty	approx. 48 kg
Loading volume (depends on programme) ¹⁾	max. 7 kg
Voltage	230-240 V
Required fuse	13 A
Total power	2350 W
Energy efficiency class	B
Energy consumption (7 kg of cotton, pre-drained at 1000 rpm) ²⁾	3.92 kWh
Average annual energy consumption	284.1 kWh
Use	Domestic
Permissible ambient temperature	+ 5°C to + 35°C

Consumption values

The consumption values have been established under standard conditions. They may deviate when the machine is operated in domestic circumstances.

Programme	Energy consumption in kWh / average drying time in min.
COTTON CUPBOARD DRY ^{2) 3)}	3.92 / 125 (7 kg load pre-drained at 1000 rpm) 3,75 (7 kg load pre-drained at 1200 rpm) 3,60 (7 kg load pre-drained at 1400 rpm) 3,20 (7 kg load pre-drained at 1800 rpm)
COTTON IRON DRY ²⁾	3.34 / 107 (7 kg load pre-drained at 1000 rpm)
SYNTHETICS CUPBOARD DRY ²⁾	1.33 / 48 (3 kg load pre-drained at 1200 rpm)

1) Different loading volume data may be needed in some countries as a result of different measuring methods.

2) in accordance with EN 61121

Hints for test institutes

Parameters possible to be checked by the Test Institutes:

- Energy consumption (corrected with final humidity) during the cupboard dry cotton cycle with nominal load.

- Energy consumption (corrected with final humidity) during the cupboard dry cotton cycle with half load.
- Final humidity (during cupboard dry cotton, iron dry cotton and cupboard dry easy care)
- Condensation efficiency (corrected with final humidity) during cupboard dry cotton cycle with nominal and half load (with valve/filter of the water recirculation system in OFF position).

All the cycles have to be checked in accordance with EN 61121 (Tumble dryers for household use – Methods for measuring the performance).

Installation



The appliance must be moved in vertical position for transport.

Appliance positioning

- It is recommended that, for your convenience, the machine is positioned close to your washing machine.
- The tumble dryer must be installed in a clean place, where dirt does not build up.
- Air must be able to circulate freely all round the appliance. Do not obstruct the front ventilation grille or the air intake grilles at the back of the machine.
- To keep vibration and noise to a minimum when the dryer is in use, it should be placed on a firm, level surface.
- Once in its permanent operating position, check that the dryer is absolutely level with the aid of a spirit level. If it is not, raise or lower the feet until it is.
- The feet must never be removed. Do not restrict the floor clearance through deeppile carpets, strips of wood or similar. This might cause heat built-up which would interfere with the operation of the appliance.



The hot air emitted by the tumble dryer can reach temperatures of up to 60°C. The appliance must therefore not be installed on floors which are not resistant to high temperatures. When operating the tumble dryer, the room temperature must not be lower than +5°C and higher than +35°C, as it may affect the performance of the appliance.



WARNING!

Should the appliance be moved, it must be transported vertically.



WARNING!

The appliance must not be installed behind the lockable door, a sliding door or a door with a hinge on the opposite side to that of the appliance.

Removing transport safety packaging



CAUTION!

Before use all parts of the transport packaging must be removed.

1. Open loading door
2. Pull off adhesive strips from inside machine on top of drum.

3. Remove foil hose and polystyrene padding from the machine.

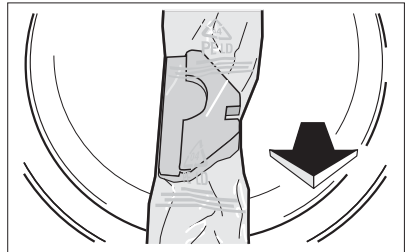
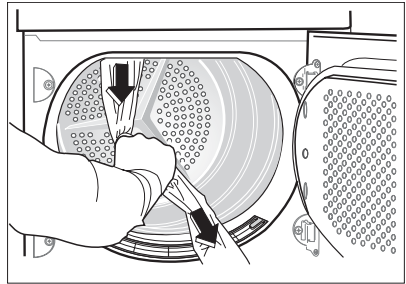

Drying rack unpacking



CAUTION!

Before use all packaging parts and rack must be removed from the drum

To unpack the rack:

1. Remove upper protection polystyrene parts by pulling them.
2. Remove the elastic band fixing the rack handle to container.

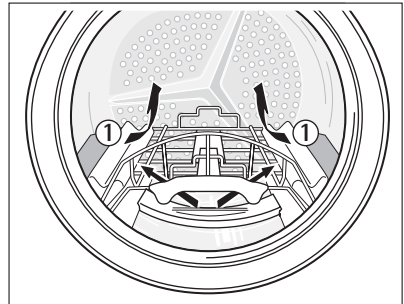

3. Pull slightly rack handle (not to the end). Grasp at it harder and lift it up.

For easiest unpacking turn the rack upside down

4. Take it carefully out of the drum.
5. Remove from the drum rest of packing elements.

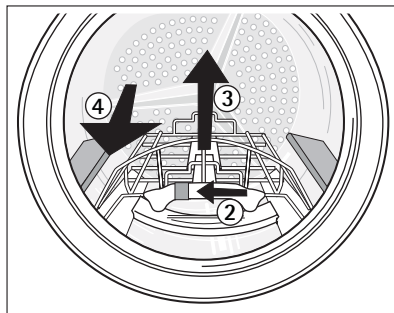

Electrical connection

Details on mains voltage, type of current and the fuses required should be taken from the rating plate. The rating plate is fitted near the loading aperture (see "Product description" chapter).

Connect the machine to an earthed socket, in accordance with current wiring regulations.



WARNING!

The manufacturer declines any responsibility for damage or injury through failure to comply with the above safety precautions.

Should the appliance power supply cable need to be replaced, this must be carried out by our Service Centre.

The appliance is supplied with a 13 amp plug fitted. In the event of having to change the fuse in the plug supplied, a 13 amp ASTA approved BS 1363/A fuse must be used.

The wires in the mains lead are coloured in accordance with the following code:

- 1 Blue - Neutral
- 2 cord clamp
- 3 Brown - Live
- 4 Green and Yellow - Earth

The wire coloured green and yellow must be connected to the terminal marked with the letter «E» or by the earth symbol \perp or coloured green and yellow.

The wire coloured blue must be connected to the terminal «N» or coloured black.

The wire coloured brown must be connected to the terminal «L» or coloured red.

Upon completion there must be no cut, or stray strands of wire present and the cord clamp must be secure over the outer sheath.

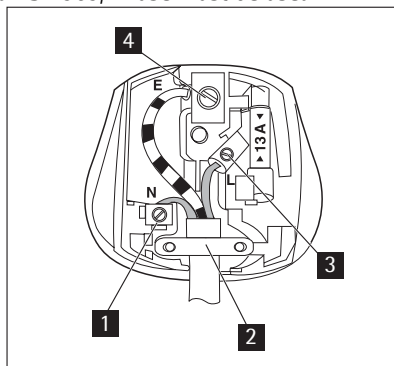

WARNING!

A cut off plug inserted into a 13 amp socket is a serious safety (shock) hazard. Ensure that the cut off plug is disposed of safely.

**WARNING!**

The power supply cable must be accessible after installing the machine.

Permanent connection

In the case of permanent connection it is necessary that you install a double pole switch between the appliance and the electricity supply (mains), with a minimum gap of 3 mm between the switch contacts and of a type suitable for the required load in compliance with the current electrical regulations.

The switch must not break the yellow and green earth cable at any point.

Door reversal

To make it easier to load or unload the laundry, the door can be reversed. This operation must only be carried out by a qualified engineer. Please contact your local service centre. The engineer will carry out the door reversal at your cost.

Special accessories

- **stacking kit**



Available from your Service Force Centre or your specialist dealer

These intermediate installation kits can be used to arrange the dryer and a washing machine (60 cm wide, front loaded) as a space-saving washer/dryer stack. The washing machine is at the bottom and the dryer is at the top.

Read carefully the instructions supplied with the kit.

- **draining kit**



Available from your Service Force Centre or your specialist dealer

Installation kit for direct draining of condensate into a basin, siphon, gully, etc. The condensate tank then no longer has to be drained, it must however remain in its intended position in the machine.

Read carefully the instructions supplied with the kit.

- **pedestal with the drawer**



Available from your Service Force Centre or your specialist dealer

To situate the dryer in optimal high and have some additional space to store (e.g. laundry). Read carefully the instructions supplied with the kit.

Service

In the event of technical faults, please first check whether you can remedy the problem yourself with the help of the operating instructions (Chapter "What to do if...").

If you were not able to remedy the problem yourself, please contact your local service centre.

In order to be able to assist you quickly, we require the following information:

- Model description
 - Product number (PNC)
 - Serial number (S No.) (for numbers, see rating plate)
 - Type of fault
 - Any error messages displayed by the appliance
- So that you have the necessary reference numbers from your appliance at hand, we recommend that you write them in here:

Model description:
PNC:
S No.:

Guarantee conditions

GB **IE** Guarantee/Customer Service

GREAT BRITAIN & IRELAND

Standard guarantee conditions

We, Electrolux, undertake that if within 12 months of the date of the purchase this Electrolux appliance or any part thereof is proved to be defective by reason only of faulty workmanship or materials, we will, at our option repair or replace the same FREE OF CHARGE for labour, materials or carriage on condition that:

- The appliance has been correctly installed and used only on the electricity supply stated on the rating plate.
- The appliance has been used for normal domestic purposes only, and in accordance with the manufacturer's instructions.
- The appliance has not been serviced, maintained, repaired, taken apart or tampered with by any person not authorised by us.
- Electrolux Service Force Centre must undertake all service work under this guarantee
- Any appliance or defective part replaced shall become the Company's property.
- This guarantee is in addition to your statutory and other legal rights.

Exclusions

- Damage or calls resulting from transportation, improper use or neglect, the replacement of any light bulbs or removable parts of glass or plastic.
- Costs incurred for calls to put right an appliance which is improperly installed or calls to appliances outside the United Kingdom.
- Appliances found to be in use within a commercial environment, plus those which are subject to rental agreements.
- Products of Electrolux manufacturer that are not marketed by Electrolux

Service and Spare Parts

In the event of your appliance requiring service, or if you wish to purchase spare parts, please contact your local Service Force Centre by telephoning

0870 5 929 929

Your telephone call will be automatically routed to the Service Force Centre covering your postcode area.

For the address of your local Service Force Centre and further information about Service Force, please visit the website at

www.serviceforce.co.uk

Before calling out an engineer, please ensure you have read the details under the heading "What to do if..."

When you contact the Service Force Centre you will need to give the following details:

1. Your name, address and postcode.
2. Your telephone number.
3. Clear concise details of the fault.
4. The model and Serial number of the appliance (found on the rating plate).
5. The purchase date.

Please note a valid purchase receipt or guarantee documentation is required for in guarantee service calls.

Customer Care

For general enquiries concerning your Electrolux appliance, or for further information on Electrolux products please contact our Customer Care Department by letter or telephone at the address below or visit our website at www.electrolux.co.uk

Customer Care Department, Electrolux Major Appliances

Addington Way, Luton

Bedfordshire, LU4 9QQ

	Tel:
Electrolux	08705 950 950 ¹⁾
AEG-Electrolux	08705 350 350 ¹⁾
Zanussi-Electrolux	08705 727 727 ¹⁾

1) Calls may be recorded for training purposes

For Customer Service in The Republic of Ireland please contact us at the address below:

Electrolux Group (Irl) Ltd

Long Mile Road, Dublin 12, Republic of Ireland

Tel: +353 (0)1 4090751

Email: service.eid@electrolux.ie

European Guarantee

This appliance is guaranteed by Electrolux in each of the countries listed at the back of this user manual, for the period specified in the appliance guarantee or otherwise by law. If you move from one of these countries to another of the countries listed, the appliance guarantee will move with you subject to the following qualifications:-

- The appliance guarantee starts from the date you first purchased the appliance which will be evidenced by production of a valid purchase document issued by the seller of the appliance.

- The appliance guarantee is for the same period and to the same extent for labour and parts as exists in your new country of residence for this particular model or range of appliances.
- The appliance guarantee is personal to the original purchaser of the appliance and cannot be transferred to another user.
- The appliance is installed and used in accordance with instructions issued by Electrolux and is only used within the home, i.e. is not used for commercial purposes.
- The appliance is installed in accordance with all relevant regulations in force within your new country of residence.

The provisions of this European Guarantee do not affect any of the rights granted to you by law.

www.electrolux.com

		
Albania	+35 5 4 261 450	Rr. Pjeter Bogdani Nr. 7 Tirane
Belgique/België/Belgien	+32 2 363 04 44	Bergensesteenweg 719, 1502 Lembeek
Česká republika	+420 2 61 12 61 12	Budějovická 3, Praha 4, 140 21
Danmark	+45 70 11 74 00	Sjællandsgade 2, 7000 Fredericia
Deutschland	+49 180 32 26 622	Muggenhofer Str. 135, 90429 Nürnberg
Eesti	+37 2 66 50 030	Pärnu mnt. 153, 11624 Tallinn
España	+34 902 11 63 88	Carretera M-300, Km. 29,900 Alcalá de Henares Madrid
France	www.electrolux.fr	
Great Britain	+44 8705 929 929	Addington Way, Luton, Bedfordshire LU4 9QQ
Hellas	+30 23 10 56 19 70	4, Limnou Str., 54627 Thessaloniki
Hrvatska	+385 1 63 23 338	Slavonska avenija 3, 10000 Zagreb
Ireland	+353 1 40 90 753	Long Mile Road Dublin 12
Italia	+39 (0) 434 558500	C.so Lino Zanussi, 26 - 33080 Porcia (PN)
Latvija	+371 67313626	Kr. Barona iela 130/2, LV-1012, Riga
Lietuva	+370 5 278 06 03	Ozo 10a, LT-08200 Vilnius

		
Luxembourg	+352 42 431 301	Rue de Bitbourg, 7, L-1273 Hamm
Magyarország	+36 1 252 1773	H-1142 Budapest XIV, Erzsébet királyné útja 87
Nederland	+31 17 24 68 300	Vennootsweg 1, 2404 CG - Alphen aan den Rijn
Norge	+47 81 5 30 222	Risløkkvn. 2 , 0508 Oslo
Österreich	+43 18 66 400	Herziggasse 9, 1230 Wien
Polska	+48 22 43 47 300	ul. Kolejowa 5/7, Warszawa
Portugal	+35 12 14 40 39 39	Quinta da Fonte - Edifício Gonçalves Zarco - Q 35 -2774-518 Paço de Arcos
Romania	+40 21 451 20 30	Str. Garii Progresului 2, S4, 040671 RO
Schweiz - Suisse - Svizzera	+41 62 88 99 111	Industriestrasse 10, CH-5506 Mägenwil
Slovenija	+38 61 24 25 731	Gerbičeva ulica 98, 1000 Ljubljana
Slovensko	+421 2 43 33 43 22	Electrolux Slovakia s.r.o., Electrolux Domáce spotrebiče SK, Seberíniho 1, 821 03 Bratislava
Suomi	www.electrolux.fi	
Sverige	+46 (0)771 76 76 76	Electrolux Service, S:t Göransgatan 143, S-105 45 Stockholm
Türkiye	+90 21 22 93 10 25	Tarlabası caddesi no : 35 Taksim İstanbul
Россия	+7 495 937 7837	129090 Москва, Олимпийский проспект, 16, БЦ "Олимпик"
Україна	+380 44 586 20 60	04074 Київ, вул.Автозаводська, 2а, БЦ "Алкон"

www.electrolux.com



To buy accessories, consumables and spare parts at our online shop please visit:
www.aeg-electrolux.co.uk

136905540-01-25072008